

























LED INDICATION / LED INDIKERING

SAC-U25

LED INDICATORS

LED indicator Green/Grön	Red/Röd	Status ENG/ SE
		Main power supply / Nätdrift
		Power failure - Emergency-light-operate / Strömavbrott - Nödljus
		Function test / Funktionstest
		Emergency duration test / Driftvaraktighetstest
		Emergency duration <2h / Driftvaraktighetstest <2h
		Illuminant - Charge over defekt / Ljuskälla - omkoppling defekt
		Battery - Charge defect / Batteri - Laddning defekt

MANUAL TEST FUNCTION

TEST button Press _sec	LED Green/Grön	Status ENG/ SE
		Main power supply/ Nätdrift
		A short time emergency operation 5sec/ Kortvarig nöddrift 5sek
		Start function test emergency operation 30sec/ Funktionstest 30sek
		Start emergency duration test 3h/ Driftvarighetstest 3h
		Stop emergency duration test/ Driftvarighetstest avbryts

ENG

Autotest

Once the unit is powered up it will automatically initiate a self test as follows:

Every week : Performs a 30 sec duration test

Every year : Performs a 3h duration test

SE

Autotest

Efter anslutning till nätspänningen aktiveras självtestet enligt nedan:

Varje vecka: Utförs ett 30 sec långt test

Varje år: Utförs ett 3h test

Explanation/ Teckenförklaring			
			
Off Släckt	On Lyser	Flashing Blinkar	Flashing 1/sec Blinkar 1/sec

SAC Nordic AB reserverar sig för eventuella faktur- eller tryckfel i denna trycksak. SAC2017-1



SAC Nordic AB • Prästtorpsvägen 16 • S-341 51 Lagan • SWEDEN • www.sacnordic.com

Safe Security Solutions

MANUAL SAC-U25

SAC-U25 73 505 50

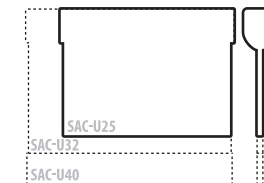

SAC-U25

Dubbelsidig hänvisningsarmatur





EMERGENCY LIGHT

SAC-U25

ENG

EMERGENCY LIGHTING

LED 25m

SAC-U25 are a reference fixture with bright LED's and long life burn time. Low energy, low maintenance and long life combined with a auto-testing system and a modern reliable technology allows the fixture to a choice for simplicity, safety and future. Complies with EN 60598-2-22.

- Pictograms (interchangeable) for the most common configurations (included)
- Can be installed on ceiling-, wall- and end-/flag-mounting (included)
- Supervised by a self-testing system
- House of aluminium and acrylic glass
- Battery backup (up to 3 hours emergency operation)
- Maintained or non-maintained
- Accessories: Pendant for ceiling (adjustable 1.5m), Shock protection, battery, LED strip, pictogram.

SE

NÖDBELYSNINGSSARMATUR

LED 25m

SAC-U25 är en enkel- /dubbelsidig hänvisningsarmatur med starka lysdioder och lång brinntid. Låg energiförbrukning, låga underhållskostnader och lång livslängd kombinerat med ett autotestande system och en tillförlitlig teknik gör armaturen till ett val för enkelhet, säkerhet och framtid. Uppfyller kraven enligt EN 60598-2-22.

- Medföljer utbytbara piktogram för de vanligaste utföranden (Pil höger, vänster och ner)
- Kan monteras på tak, vägg, sida s.k. flaggmontering (medföljer)
- Övervakad med ett självtestande system
- Aluminiumhus och akrylglas
- Inbyggd batteri backup (upp till 3 tim nöddrift)
- Permanentdrift eller nöddrift
- Tillbehör: Takpendelupphängning justerbar 1,5m, bollskydd, batteri, LED-list, piktogram.

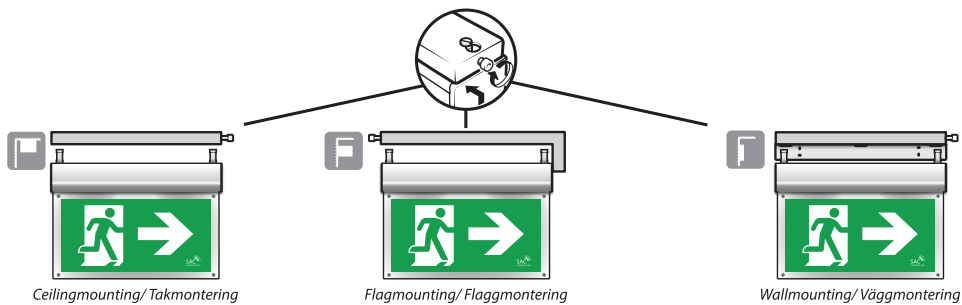

Art.no	E-no	Model	Light source	Viewing distance	Class	Battery backup	Battery Weight	
460401	73 505 50	SAC-U25	15 LED	25 m	IP40	NiMH 4,8V 0,8 Ah 3 h	1,0 kg	
460402	73 505 51	SAC-U32	15 LED	32 m	IP40	NiMH 4,8V 0,8 Ah 3 h	1,3 kg	
460424	73 416 15	SAC-U40	-	40 m	-	-	0,7 kg	
460415	73 513 44	Pendant for ceiling / Takpendel						
460425	73 513 45	(U25) Disabled pictogram / Piktogram rullstol						
460412	73 513 50	Shock protection cover / Bollskydd						
460476	-	Battery pack / Batteripack						
460475	-	LED-strip / LED-list (SAC-U25)						



Piktogram

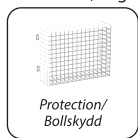

Protection/
Bollskydd

INSTALLATION & LED / BATTERY REPLACEMENT

SAC-U25

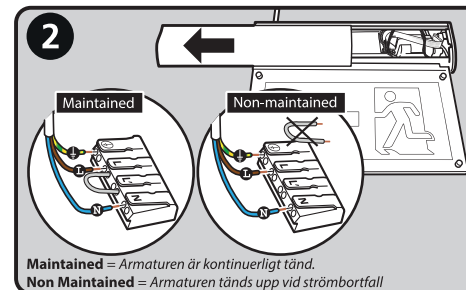
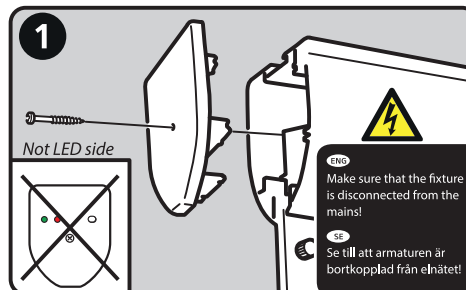

BATTERY REPLACEMENT / BATTERIBYTE

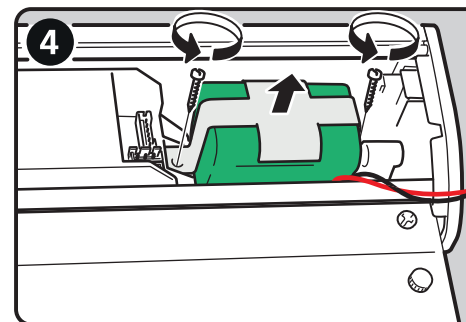
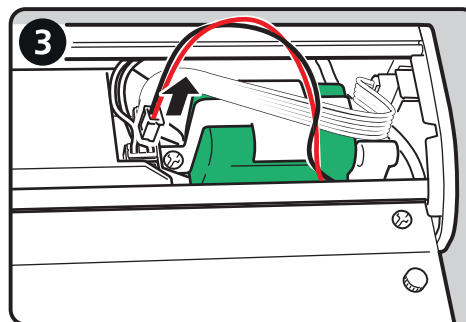

LED-STRIP REPLACEMENT / LED-LIST BYTE

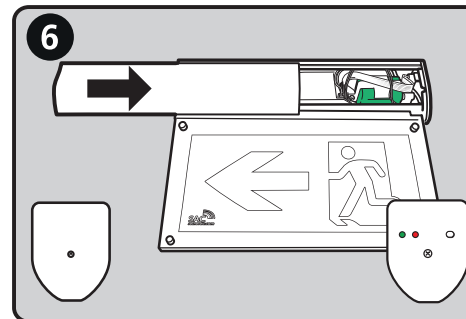
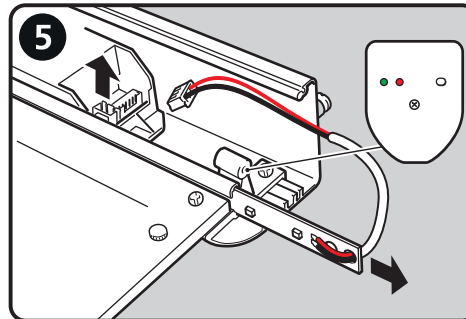

ENG

1. Loosen the screw on the side. The side where the LEDs are not!
2. Slide the cover to the side
3. Unplug the battery (carefully!)
4. Loosen the screws on the battery compartment and replace the battery.
5. Carefully pull the LED bar from the slot.
6. Follow the above steps in reverse order.

SE

1. Lossa skruven på sidan. Den sidan där inte lysdioderna sitter!
2. Skjut luckan åt sidan
3. Dra ut kontakten till batteriet (försiktigt!)
4. Lossa skruvarna till batterihållaren och byt batteriet.
5. Dra försiktigt ut LED-skenan ur skåran.
6. Följ stegen ovan i omvänd ordning.