



Speaker Systems

APPLICATIONS

- Band P.A.
- Personal monitor
- Small theatres
- Auditoriums
- Piano bar
- DJ
- Stage monitor
- Conference rooms
- Fixed installations in live clubs
- Pubs
- Gyms

KEY FEATURES

- 2-way processed active system
- Polypropylene enclosure
- 1 x 5" custom woofer
- 1 x 1" neodymium silk dome tweeter
- 60W/30W built-in amplifier cont. RMS LF/HF
- 80W/40W built-in amplifier max. RMS LF/HF
- 160W/80W built-in amplifier max. peak LF/HF
- 2 x M6 suspension points
- Low noise toroidal transformer power supply
- Available in white color
- Completely manufactured in Italy



Designed, Engineered
and Manufactured in ITALY

PRODUCT DESCRIPTION

The FBT J5A series speakers feature lightweight, yet rugged gas injected molded polypropylene cabinet construction. Available in black or white finish the FBT J5A series speakers modern cabinet appearance provides fixed installations with an elegant design that blends into any decor. The asymmetrical shape of the FBT J5A cabinet also allows use as a powered floor stage monitor. The FBT J5A is of two way design incorporating an 5" low frequency woofer and 1" HF custom compression driver coupled to a 90°H x 90°V horn. The active internal crossover is at a fixed frequency of 3.5kHz. With a frequency range of 80Hz - 20kHz the FBT J5A speaker provide high fidelity sound for both speech and music applications with a maximum SPL of 117dB. A front face steel grille protects the speaker from external damage. The bi-amplified FBT J5A active speaker feature a 80W RMS low frequency amp and a 40W RMS high frequency amp. The control panel features a level control, HP filter switch, mic/line selector, led power on, protection led indicator, a balanced Neutrik input combo-jack, balanced XLR link out. The two M6 fly points built into the cabinet along with the optional mounting brackets allow the FBT J5A speaker to be surface mounted on walls or ceilings. A standard 1,38" speaker stand socket allows the FBT J5A to be mounted on speaker stand.

ELECTRONIC SPECIFICATIONS

System Type	2 Way
Internal amplifiers*	cont.: 60W+30W RMS max.: 80W+40W RMS max peak: 160W+80W
Input Impedance	22 kOhm
Frequency Response	80Hz - 20kHz (@-6dB)
Maximum SPL cont.peak**	113dB / 117dB
Dispersion	90° H x 90°V
Crossover Frequency	3.5kHz
AC Power Requirement	75VA

PHYSICAL SPECIFICATIONS

Low Frequency Woofer	5" / 1" coil
High Frequency Driver	1" dome / 0.75" coil
Input Connectors	Balanced Neutrik combo jack, XLR, 1/4" TRS
Net Dimensions (WxHxD) inch	6.69 x 10.82 x 7.08
Shipping Dimensions (WxHxD) inch	9.44 x 13.58 x 9.25
Net Weight	7.49 lbs
Shipping Weight	9.25 lbs
Enclosure Material	polypropylene
Grille	Steel with powder coat black or white paint finish

* Cont.: 500mS burst, rms power on nominal speaker impedance
Max.: 2mS burst, rms power on nominal speaker impedance
Max peak: based on max peak output voltage and nominal speaker impedance

** Cont. SPL: free space, based on continuous power amp rating and LF transducer average sensitivity data, 125mS time average
Peak SPL: free space, based on max. peak power amp rating and system peak sensitivity, 10mS time average

DIAGRAMS

Horizontal polar diagrams

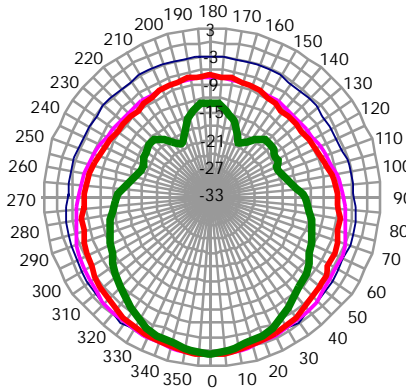

Horizontal polar diagrams

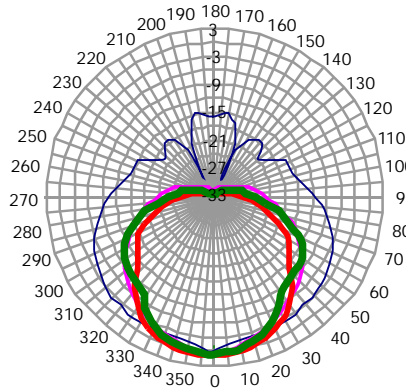

Vertical polar diagrams

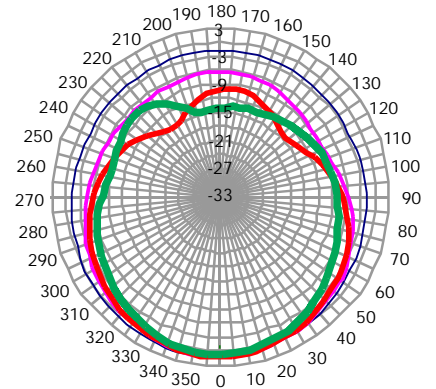

Vertical polar diagrams

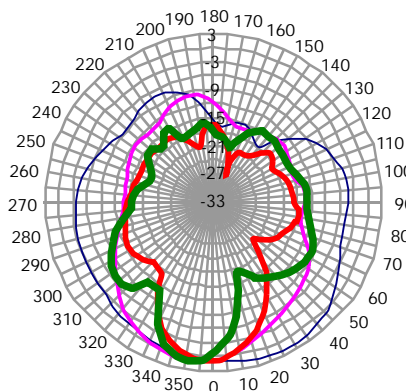
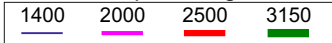

Vertical polar diagrams

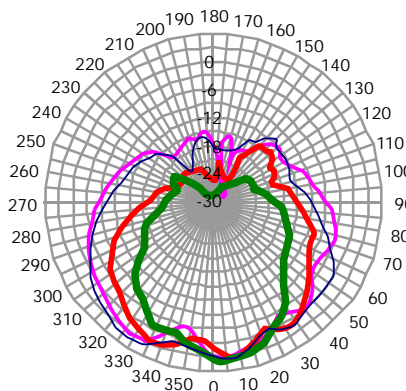

Vertical polar diagrams

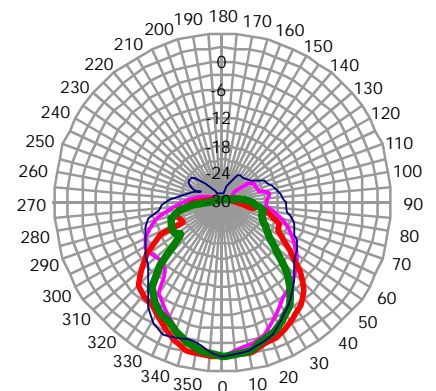
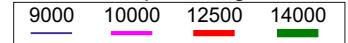

dB SPL FREQUENCY RESPONSE

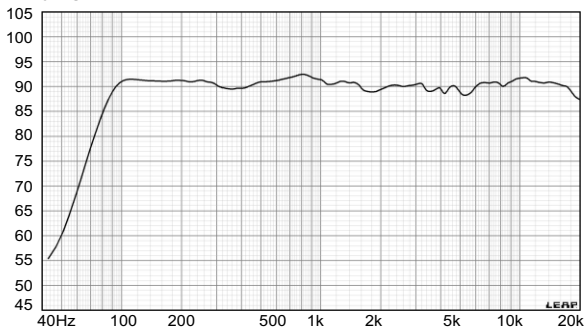

HORIZONTAL BEAMWIDTH (-6dB)

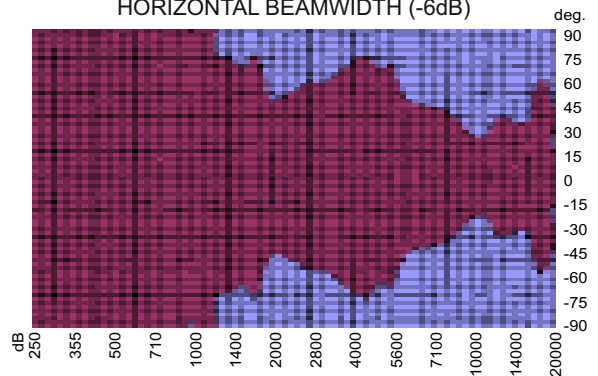

DIMENSIONAL DRAWINGS

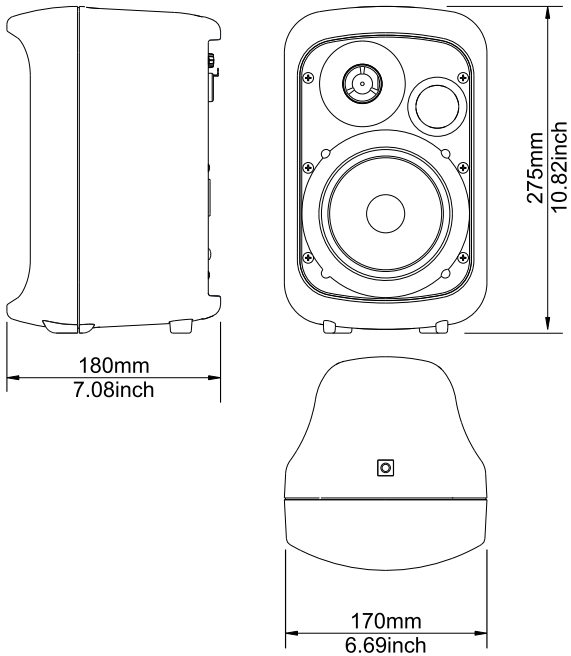

CONTROL PANEL

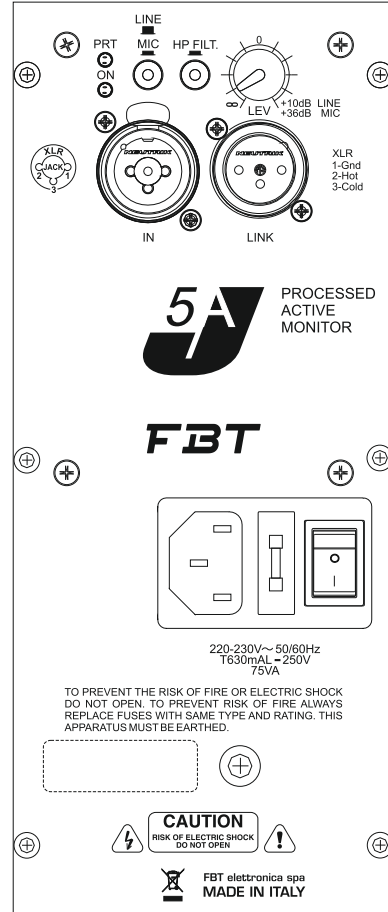

ACCESSORIES

